

Circus solo

0176

AM
STUDIO
CUSTOM LIGHTING

VIBIA

Design By Antoni Arola

The versatile hanging Circus Solo accent spotlight allows for the definition of spaces and the creation of different ambiances. The narrower angles of under 20° are perfect for generating high contrasts and distant projections.

Spec sheet

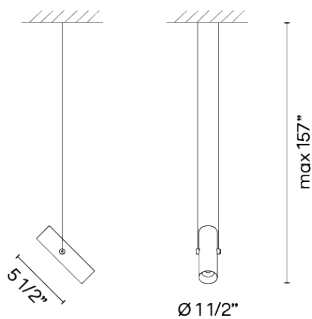
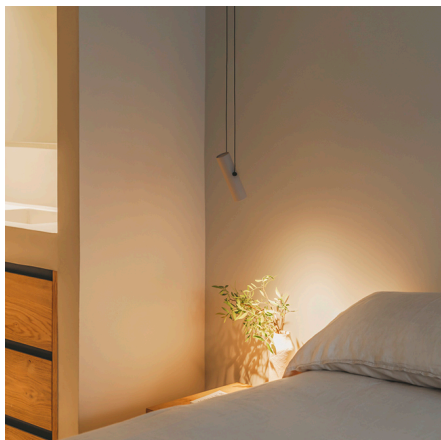





undefined: undefined

Any modifications require a minimum order quantity and extra lead time

Finish	 24 Beige M1 NCS S 2005-Y50R
	 11 Black NCS S 8500-N
LED	2700 K / 3000 K / 3500 K
Dimming	CASAMBI / 0-10V / DALI 0-10V 1-10V

Installation type Built-in M / Surface

LED	CRI>90 680 lm 94,4 2700 K / 3000 K / 3500 K
Driver	Constant Current 400 110-240 V V 50-60 Hz HZ
	   50-60Hz 
Application	Pendants
Packaging	Box
	Gross weight
	Net weight

Lighting effect

Accent Spotlight

Narrow: Angles less than 20°. Suitable for generating high contrasts or projections at far distances.

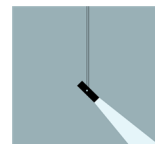

Photometric Data

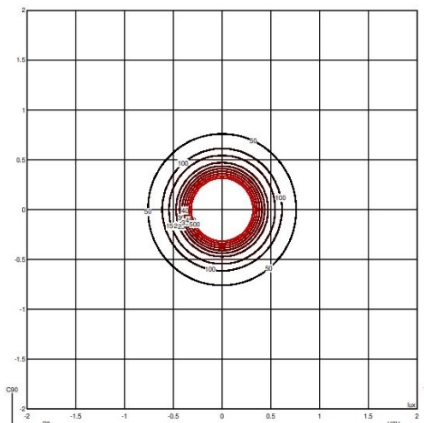
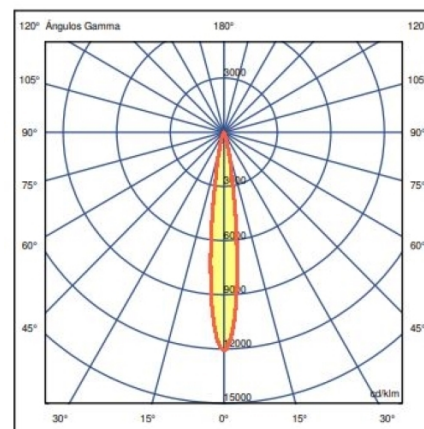

Efficiency	76.753 lm/W
Coordination System	CG
Total Flux	575.6 lm
Maximum Value	12087.14 cd/klm

All of our products come with a two year standard warranty. Check US & Canada Term and Condition sales@vibia.com

VIBIA, INC.

Office / Oficina
272 Fernwood Ave. Edison, NJ 08837. USA

International T 732 417 1700
Spain / Portugal T +34 934 796 970

sales@vibia.com
www.vibia.com/us/usa

Circus solo

0177

Design By Antoni Arola

VIBIA

The Circus Solo pendant spotlight is inspired by a trapeze artist providing definition of spaces using medium contrasts and medium-distance projections. This model give options for Static white, Tunable white, and Tunable red LED color temperature control.

Spec sheet



Finish	 11 Black NCS S 8500-N
	 24 Beige M1 NCS S 2005-Y50R
LED	2700 K / 3000 K / 3500 K / Tunable Red / Tunable White
Dimming	CASAMBI / DALI 0-10V 1-10V / 0-10V

Installation type Surface / Built-in M

LED CRI>90 680 lm 94,4
2700 K / 3000 K / 3500 K / Tunable Red / Tunable White

Driver Constant Current 400 110~240 V V
50~60 Hz HZ

LED IP20  50-60Hz 

Application Pendants

Packaging Box

Gross weight
Net weight

Lighting effect

Accent Spotlight

Narrow: Angles less than 20°. Suitable for generating high contrasts or projections at far distances.

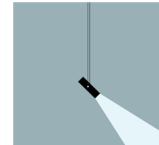

Photometric Data

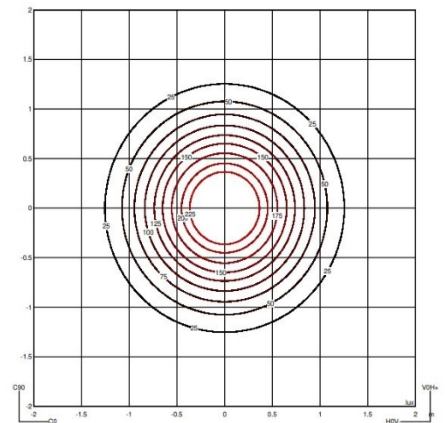
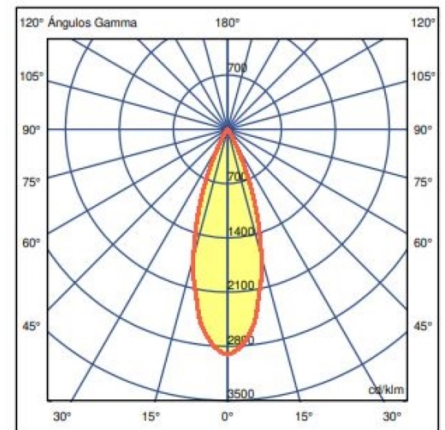

Efficiency	78.001 lm/W
Coordination System	CG
Total Flux	585.0 lm
Maximum Value	2905.10 cd/klm

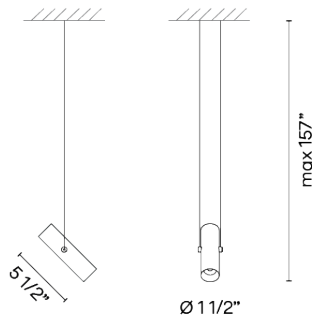

undefined: undefined

Any modifications require a minimum order quantity and extra lead time

All of our products come with a two year standard warranty. Check US & Canada Term and Condition sales@vibia.com

VIBIA, INC.

Office / Oficina
272 Fernwood Ave. Edison, NJ 08837. USA

International T 732 417 1700
Spain / Portugal T +34 934 796 970

sales@vibia.com
www.vibia.com/us/usa

Circus solo

0178

VIBIA

Design By Antoni Arola

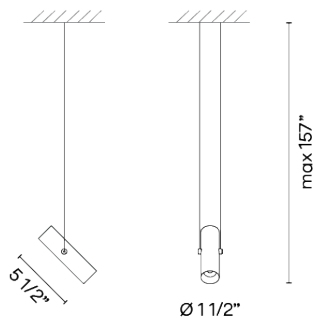
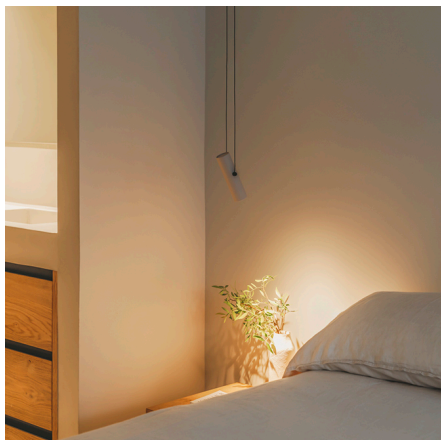

The Circus Solo pendant spotlight over 40° spread generates moderate contrasts and closer-distance projections. This model is available for Static white or Tunable White LED color temperature to be controlled precisely from cold to warm white according to the desired effect.

Spec sheet



undefined: undefined



Any modifications require a minimum order quantity and extra lead time

Finish	 24 Beige M1 NCS S 2005-Y50R
	 11 Black NCS S 8500-N
LED	2700 K / 3000 K / 3500 K / Tunable White
Dimming	0-10V / DALI 0-10V 1-10V / CASAMBI

Installation type Built-in M / Surface

LED CRI>90 680 lm 94,4
2700 K / 3000 K / 3500 K / Tunable White

Driver Constant Current 400 110~240 V V
50~60 Hz HZ

LED IP20  50-60Hz 

Application Pendants

Packaging Box

Gross weight
Net weight

Lighting effect

Accent Spotlight

Narrow: Angles less than 20°. Suitable for generating high contrasts or projections at far distances.

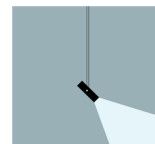

Photometric Data

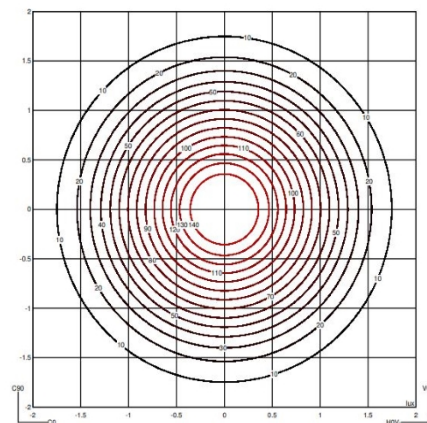
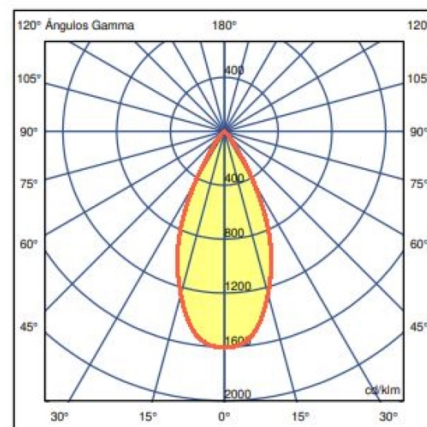

Efficiency	79.258 lm/W
Coordination System	CG
Total Flux	594.4 lm
Maximum Value	1606.43 cd/klm

All of our products come with a two year standard warranty. Check US & Canada Term and Condition sales@vibia.com

VIBIA, INC.

Office / Oficina

272 Fernwood Ave. Edison, NJ 08837. USA

International T 732 417 1700

Spain / Portugal T +34 934 796 970

sales@vibia.com

www.vibia.com/us/usa

Circus solo

0182

Design By Antoni Arola

VIBIA

The hanging Circus Solo provides a subtly directed diffused light, perfect for close-up lighting applications. This model is available in several LED color temperatures from cold to warm white and red according to the effect to be created.

Spec sheet

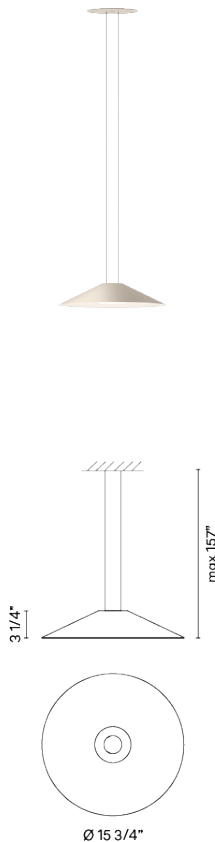

undefined: undefined

Any modifications require a minimum order quantity and extra lead time

Finish

11 Black
NCS S 8500-N

24 Beige M1
NCS S 2005-Y50R

LED

2700 K / 3000 K / 3500 K / Tunable
Red / Tunable White

Dimming

0-10V / CASAMBI / DALI 0-10V 1-10V

Installation type

Built-in M / Surface

LED

CRI>90 1763 lm 137.7
2700 K / 3000 K / 3500 K / Tunable
Red / Tunable White

Driver

Constant Current 400 110-240 V V
50-60 Hz HZ

LED IP20 50-60Hz

Application

Pendants

Packaging

Box

Gross weight
Net weight

Lighting effect

Close Proximity

Lighting applications for illumination in close proximity to the user



Photometric Data

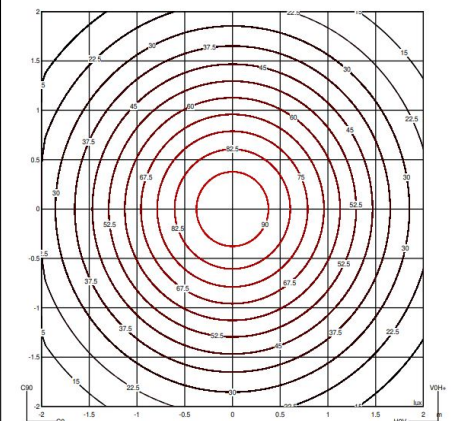
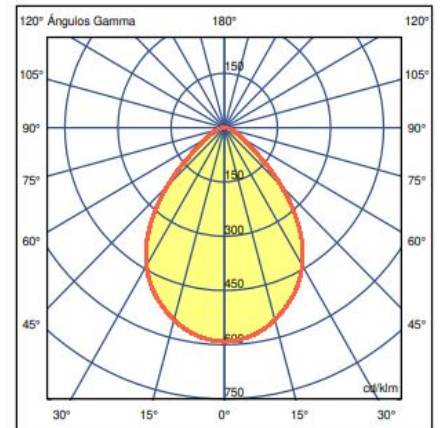

Efficiency 75.802 lm/W
Coordination System CG
Total Flux 1008.2 lm
Maximum Value 591.08 cd/klm

All of our products come with a two year standard warranty. Check US & Canada Term and Condition sales@vibia.com

VIBIA, INC.

Office / Oficina
272 Fernwood Ave. Edison, NJ 08837. USA

International T 732 417 1700
Spain / Portugal T +34 934 796 970

sales@vibia.com
www.vibia.com/us/usa

Circus solo

0185

Design By Antoni Arola

VIBIA

The Circus Solo pendant provides a subtly directed diffused lighting. This model is available in several color temperatures from cold to warm white and tunable red which transitions from 2700K to red.

Spec sheet

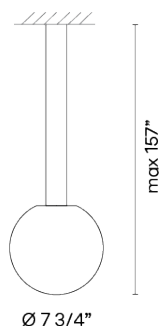
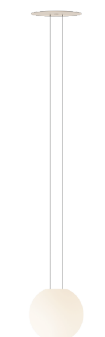
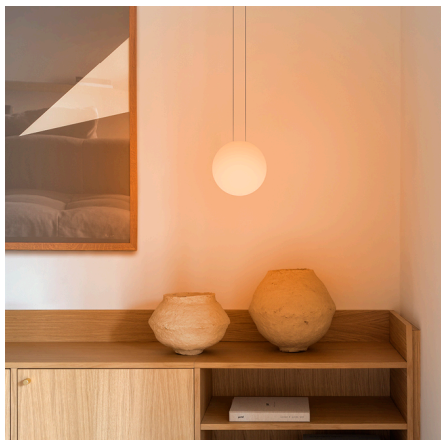

Ø 7 3/4"

undefined: undefined

Any modifications require a minimum order quantity and extra lead time

Finish

● 11 Black
NCS S 8500-N

● 24 Beige M1
NCS S 2005-Y50R

LED

2700 K / 3000 K / 3500 K / Tunable Red / Tunable White

Dimming

0-10V / DALI 0-10V 1-10V / CASAMBI

Installation type



Surface / Built-in M

LED

CRI>90 759 lm 113.4
2700 K / 3000 K / 3500 K / Tunable Red / Tunable White

Driver

Constant Current 400 110-240 V V
50-60 Hz HZ

LED IP20  50-60Hz 

Application

Pendants

Packaging

Box

Gross weight
Net weight

Lighting effect

Volumetric Diffuser

Subtly directed, diffused light that generates a soft hierarchy of light on to the illuminated surface

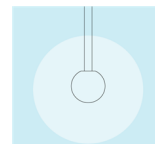

Photometric Data

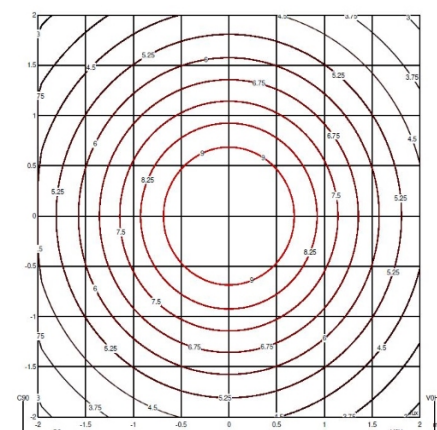
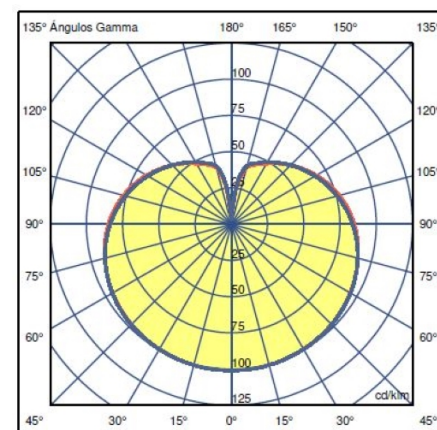

Efficiency 86.569 lm/W
Coordination System CG
Total Flux 623.3 lm
Maximum Value 100.91 cd/klm

All of our products come with a two year standard warranty. Check US & Canada Term and Condition sales@vibia.com

VIBIA, INC.

Office / Oficina
272 Fernwood Ave. Edison, NJ 08837. USA

International T 732 417 1700
Spain / Portugal T +34 934 796 970

sales@vibia.com
www.vibia.com/us/usa

Circus solo

0187

Design By Antoni Arola

VIBIA

The large dimension pendant model of Circus Solo provides a voluminous diffused effect. It is available in Static white, Tunable white, and Tunable red Color temperature options.

Spec sheet

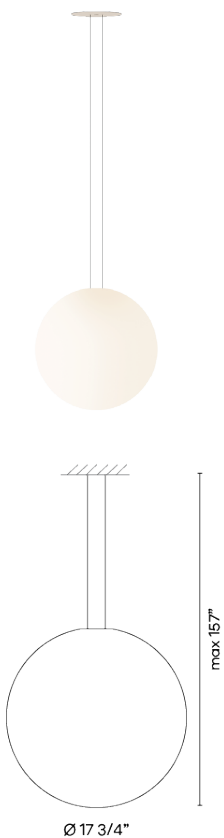

undefined: undefined



Any modifications require a minimum order quantity and extra lead time

Finish	 11 Black NCS S 8500-N
	 24 Beige M1 NCS S 2005-Y50R
LED	2700 K / 3000 K / 3500 K / Tunable Red / Tunable White
Dimming	CASAMBI / 0-10V / DALI 0-10V 1-10V

Installation type Surface / Built-in M

LED CRI>90 2588 lm 132
2700 K / 3000 K / 3500 K / Tunable Red / Tunable White

Driver Constant Current 600 120-277 V V
50-60 Hz HZ

LED IP20  50-60Hz 

Application Pendants

Packaging Box

Gross weight
Net weight

Lighting effect

Volumetric Diffuser

Subtly directed, diffused light that generates a soft hierarchy of light on to the illuminated surface

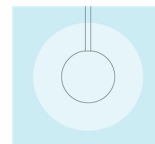

Photometric Data

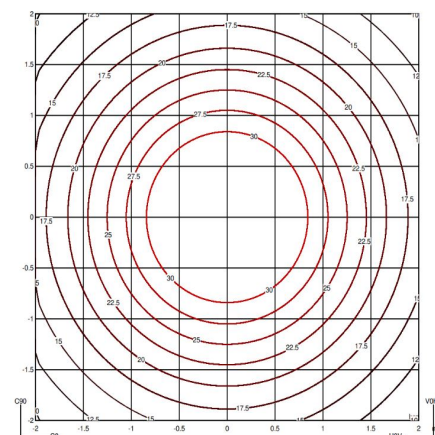
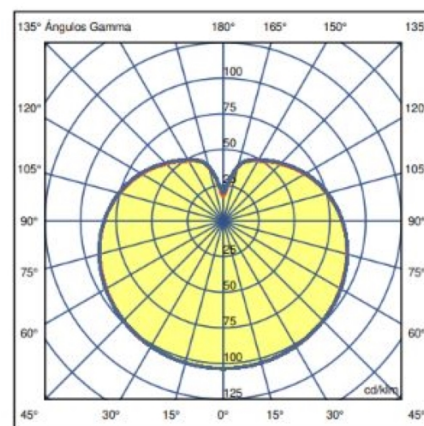

Efficiency	103.014 lm/W
Coordination System	CG
Total Flux	2142.7 lm
Maximum Value	103.44 cd/klm

All of our products come with a two year standard warranty. Check US & Canada Term and Condition sales@vibia.com

VIBIA, INC.

Office / Oficina
272 Fernwood Ave. Edison, NJ 08837. USA

International T 732 417 1700
Spain / Portugal T +34 934 796 970

sales@vibia.com
www.vibia.com/us/usa

Circus solo

0193

VIBIA

Design By Antoni Arola

Circus Solo double sphere pendant model suspended from a slim track that provides a voluminous diffused lighting. Perfect for creating warm ambiances.

Spec sheet

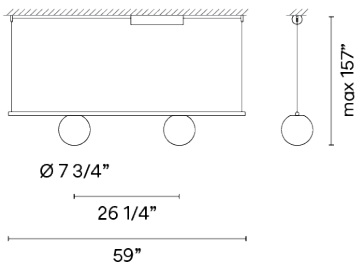
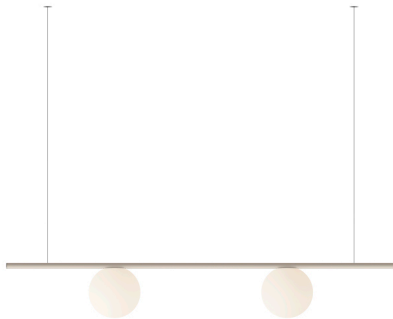

undefined: undefined

Any modifications require a minimum order quantity and extra lead time

Finish

11 Black
NCS S 8500-N

24 Beige M1
NCS S 2005-Y50R

LED

2700 K / 3000 K / 3500 K

Dimming

DALI 0-10V 1-10V / 0-10V / CASAMBI

Installation type

Remote Micro / Surface

LED

CRI>90 1518 lm 113.4
2700 K / 3000 K / 3500 K

Driver

Constant Current 400 220~240 V V
50~60 Hz HZ

LED IP20  50-60Hz 

Application

Pendants

Packaging

Box

Gross weight
Net weight

Lighting effect

Volumetric Diffuser

Subtly directed, diffused light that generates a soft hierarchy of light on to the illuminated surface

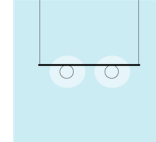

All of our products come with a two year standard warranty. Check US & Canada Term and Condition sales@vibia.com

VIBIA, INC.

Office / Oficina

272 Fernwood Ave. Edison, NJ 08837. USA

International T 732 417 1700

Spain / Portugal T +34 934 796 970

sales@vibia.com

www.vibia.com/us/usa

Circus solo

0196

VIBIA

Design By Antoni Arola

The Circus Solo pendant with double shade provides a subtly directed diffused lighting establishing a smooth hierarchy of light over the illuminated surface. This model is available in several temperatures from cold to warm white and red with the aim of creating distinctive ambiances.

Spec sheet

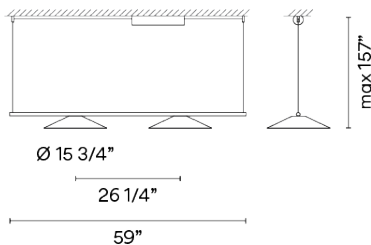

undefined: undefined

Any modifications require a minimum order quantity and extra lead time

Finish

11 Black
NCS S 8500-N

24 Beige M1
NCS S 2005-Y50R

LED

2700 K / 3000 K / 3500 K

Dimming

DALI 0-10V 1-10V / CASAMBI / 0-10V

Installation type

Surface / Remote Micro

LED

CRI>90 3104 lm 139.8
2700 K / 3000 K / 3500 K

Driver

Constant Current 700 220~240 V V
50~60 Hz HZ

LED IP20  50-60Hz 

Application

Pendants

Packaging

Box

Gross weight
Net weight

Lighting effect

Close Proximity

Lighting applications for illumination in close proximity to the user

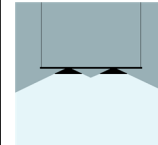

All of our products come with a two year standard warranty. Check US & Canada Term and Condition sales@vibia.com

VIBIA, INC.

Office / Oficina
272 Fernwood Ave. Edison, NJ 08837. USA

International T 732 417 1700
Spain / Portugal T +34 934 796 970

sales@vibia.com
www.vibia.com/us/usa